

# SI2000 G2 Terrace Doors – Water Performance

## SINGLE — OUTSWING

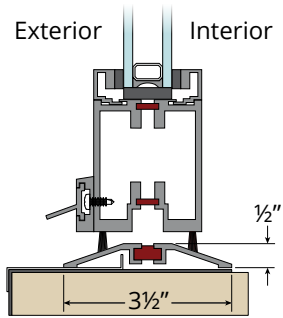

**ADA Sill**  
Limited/no water performance  
ADA compliant

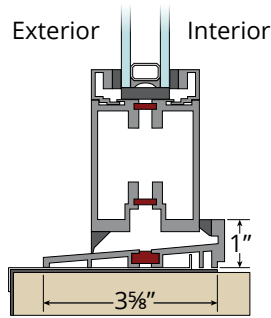

**Standard Outswing Sill**  
6PSF lab water performance  
4PSF field water performance

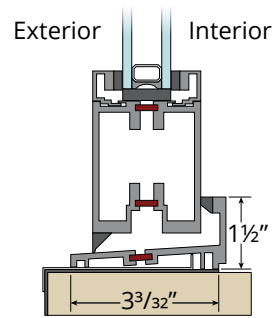

**High Performance Outswing Sill**  
10PSF lab water performance  
6.67PSF field water performance

## FRENCH — OUTSWING

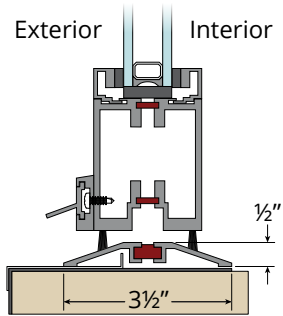

**ADA Sill**  
Limited/no water performance  
ADA compliant

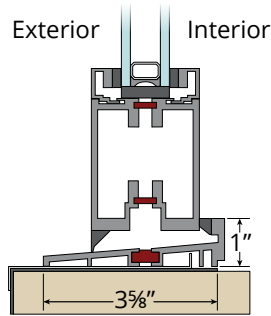

**Standard Outswing Sill**  
6PSF lab water performance  
4PSF field water performance

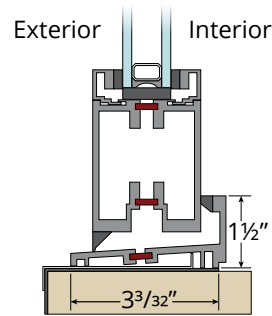

**High Performance Outswing Sill**  
6PSF lab water performance  
4PSF field water performance

## SINGLE — INSWING

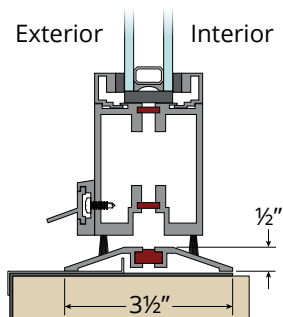

**ADA Sill**  
Limited/no water performance  
ADA compliant

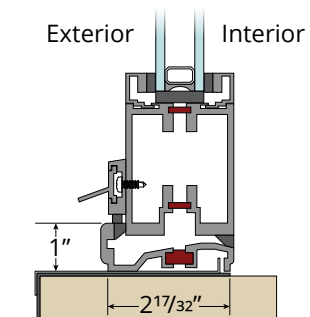

**Standard Inswing Sill**  
Limited/no water performance

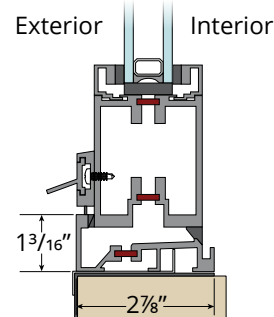

**High Performance Inswing Sill**  
Not tested

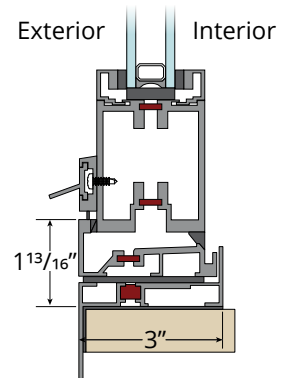

**High Performance Inswing Sill with Thermal Sill Pan**  
4PSF lab water performance  
2.67PSF field water performance

## FRENCH — INSWING

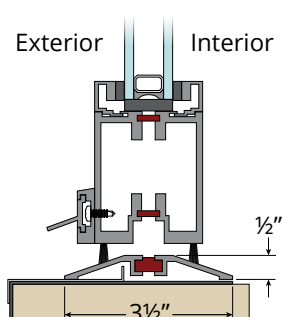

**ADA Sill**  
Limited/no water performance  
ADA compliant

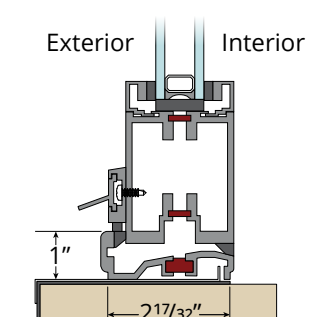

**Standard Inswing Sill**  
Limited/no water performance

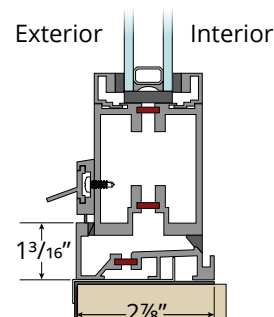

**High Performance Inswing Sill**  
Not tested

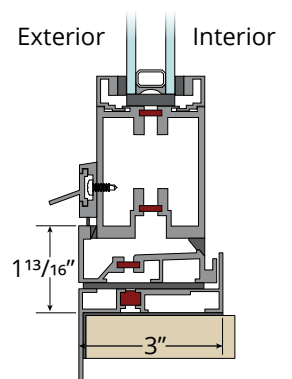

**High Performance Inswing Sill with Thermal Sill Pan**  
4PSF lab water performance  
2.67PSF field water performance