

SEGMENTED RADIUS FOLDING GLASS WALL SYSTEMS



The illusion of a curve, without rounded components

Constructed with the same precision of Solar Innovations® standard Bifold Door Systems, our Segmented Radius Folding Glass Walls give a curved wall appearance to any size opening. Though there are no truly-curved surfaces, each panel, head, and sill member are angled slightly from each other, giving the illusion of a curve. At each joint there is enough tolerance at the head and sill to allow the roller assemblies to gently transist to the next segment. Equipped with any number of panels, this operation not only applies to doors, but also window openings.

FEATURES

OPERATION:

- Top or bottom load
- In-fold or out-fold operation
- Endless configurations possible
- Swing door integration

FRAMING:

- Aluminum
- Frame widths: 3 $\frac{3}{8}$ ", 2 $\frac{7}{16}$ ", and 1 $\frac{5}{8}$ " (G3 only)
- Up to 3' x 15' panels and larger
- Standard, high performance and ADA compliant sills
- Matching sidelites and transoms
- LEED friendly system including recycled content

HARDWARE:

- Multiple handle styles and finishes
- Panic hardware and closer options available
- Roller assemblies designed to minimize and simplify panel maintenance
- Zero-maintenance extruded aluminum hinges with stainless steel pins
- Custom manufactured pulls and locks
- Closers (overhead)

GLAZING:

- Designed to accommodate almost any glazing infill including glass, acrylic, polycarbonate and solid panels, from $\frac{3}{16}$ " to 1 $\frac{1}{2}$ "

PERFORMANCE:

- Air, water, structural, impact, acoustical and thermally tested options

FINISHES:

- Standard AAMA 2603 paint finishes: Black, White, Sandstone, Natural Clay, Bronze and Hartford Green
- AAMA 611 Class I anodized finishes: Clear, Dark Bronze
- Standard AAMA 2605 powder coat finishes: Black, White, Sandstone, Natural Clay, Bronze and Hartford Green
- Premium AAMA powder coat finishes
- Custom finishes:
 - Fluoropolymer (50% or 70%): AAMA 2605
 - Faux wood (Decoral)
 - Dual finish — interior/exterior applications

OPTIONS:

- Wood veneer or metal cladding
- Framed and cartridge retractable screen options
- Manufacturer-installed sill drain tubes, if required
- Mullions, decorative muntins, simulated divided lites (SDLs), interior and exterior grids

HARDWARE

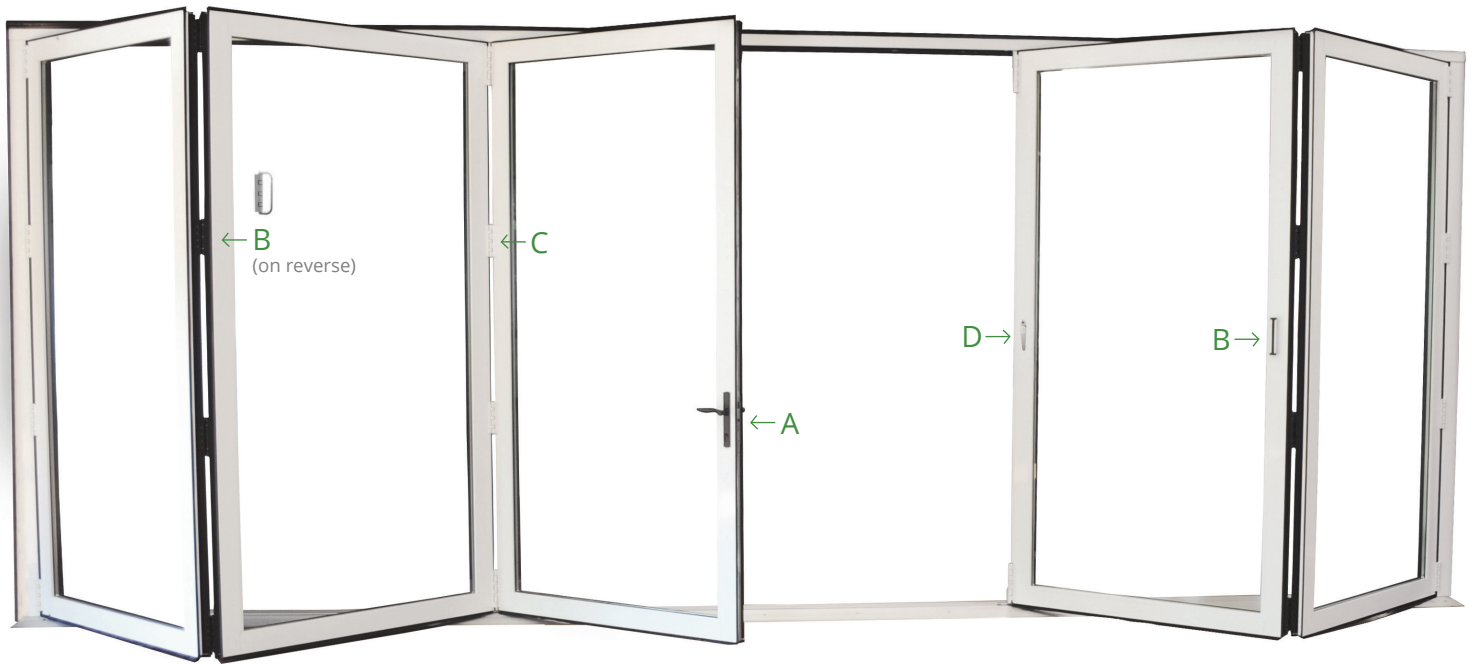

A: Handles

SOLID BRASS — COASTAL APPLICATIONS*



Toronto
(Standard)

A F
C G
E H



Atlanta

F G



Dallas

A H
F I
G



München

A G
B H
C I
F



Ródos

B G
C H
F

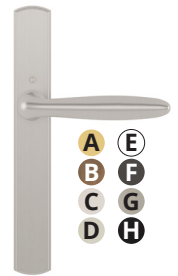

Verona

A E
B F
C G
D H

Finish Options

A Polished Brass	B Antique Brass	C Brushed Chrome*	D Polished Chrome*	E White
F Matte Black	G Satin Nickel*	H Rustic Umber	I Dark Bronze Metallic	

*Coastal applications are only available with select finish options.

ALUMINUM— INLAND APPLICATIONS



Frankfurt

A E
B F



London

A E
C F
D

A Silver	D Grey Brown
B Chestnut	E White
C Alpine Frost	F Matte Black

ZAMAC/BRASS — INLAND APPLICATIONS (G2 ONLY)



Allegro

Satin Chrome
Polished Chrome*
Polished Brass



Torino

Antique Brass
Oil Rubbed Bronze
Dark Bronze PC



Venice

Black PC	Dark Bronze
White PC	Pewter

* Not available for Torino

FOR "KEYED ALIKE" APPLICATIONS Commercial core



AR2190

- Bright Brass
- Satin Brass
- Dark Bronze
- Bright Stainless
- Satin Stainless

Additional handle styles, colors, and back plate options available upon request. Non-standard handle options may increase lead times and/or cost. All handles available with thumbturn interior lock with lever exterior, lever interior and exterior, and thumbturn interior lock with keyed exterior options.

B: Pull Hardware



Recessed Pull
(In-Fold)

Extruded Hinge Pull
(Out-Fold)

Low Profile Handle

C: Hinge



Surface Mount Hinge

D: Locks



Two-Point Locking Handle

Two-Point Keyed Locking Handle*

Thumb Turn Lock

Standard Flush Bolt

* Additional cost. Not compatible with Extra Narrow systems.

Pull Hardware, Hinge, and Lock Finish Options



Custom color options are also available upon request.

Closer, Catch, & Limiter



D Series 7414 Door Closer



D Series TS93 Door Closer

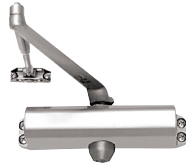

C Series PR82 Door Closer



Standard Adjustable Door Catch



Extended Adjustable Door Catch*



Door Limiter

Door Closer Finishes: Aluminum Painted, Bronze, and Black

Adjustable Door Catch Finishes: Clear Anodized and Dark Bronze Anodized

* For Panic Bar applications

Commercial Panic Hardware Options



Exterior Entry Trim Square



Mortise Panic



Impact Panic*



Push/Pull



Push Only

Wire Pulls

Passive Hardware Sets



Square Commercial



Toronto

* G2 only. Concealed vertical rod.

Please Note: All hardware is subject to vendor availability. Custom finishes may be available upon request at additional lead time and/or cost. Solar Innovations® reserves the right to discontinue any hardware option at any time. Please be sure to visit solarinnovations.com for additional product information.

CONFIGURATIONS/OPERATION EXAMPLES

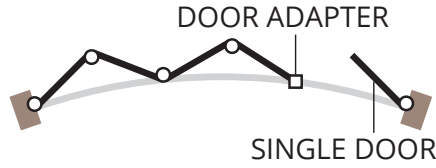

Custom configurations available upon request.

GRID OPTIONS

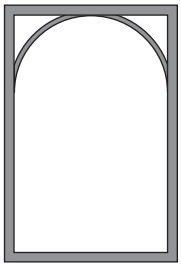

Arched Grid

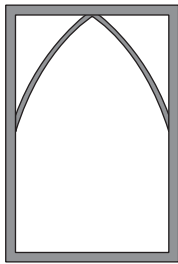

Gothic Grid

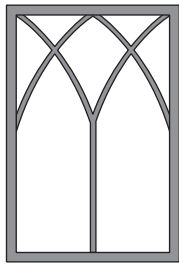

Double Gothic Grid

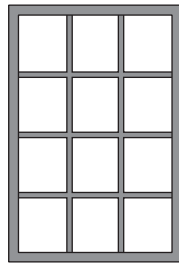

Traditional Grid

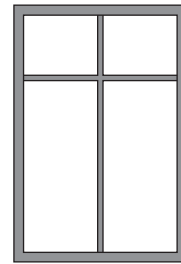

Cross Grid

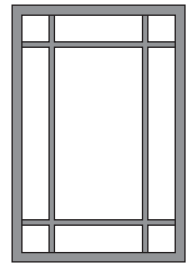

English Grid

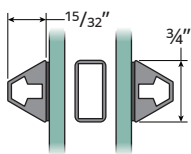
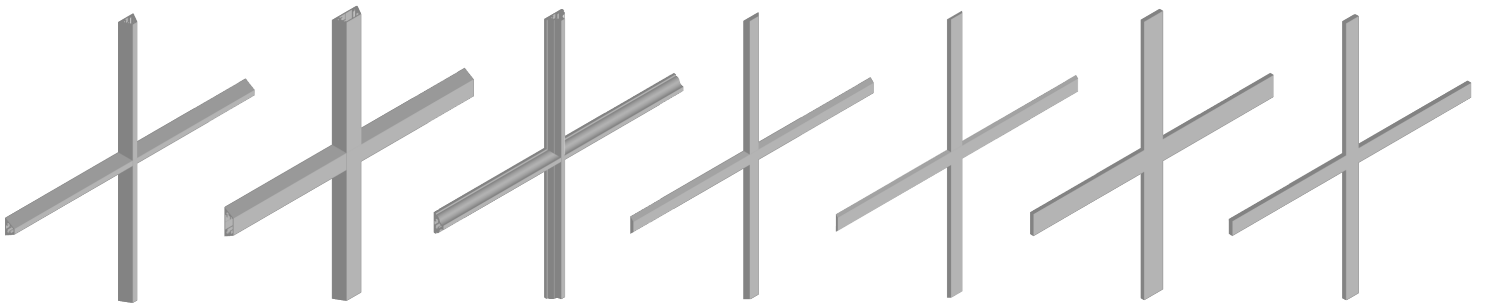

Traditional with SDL

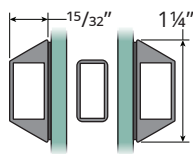

Wide Traditional with SDL

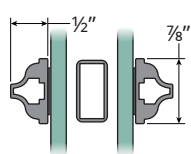

Ogee with SDL

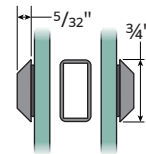

Low Profile with SDL

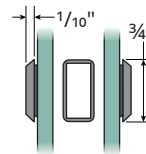

Thin Low Profile with SDL

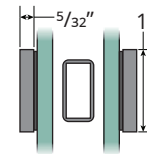

Simulated Steel with SDL

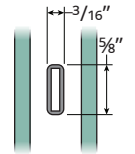

Interior Muntin in Insulated Glass

Like-sized grids can be mixed and matched, for example:

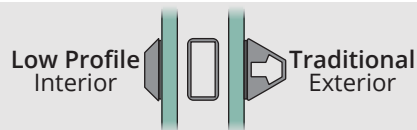

Low Profile Interior

Traditional Exterior

FINISH OPTIONS

Paint AAMA 2603 (5 year warranty). Finishes available while in stock.



Anodized Additional cost



Powder Coat Solids STANDARD - AAMA 2605 (10 year; up to 20 year warranty). Scratch & fade resistant; contains no VOCs.*



Powder Coat Solids PREMIUM - AAMA 2605 (10 year; up to 20 year warranty). Scratch & fade resistant; contains no VOCs.*

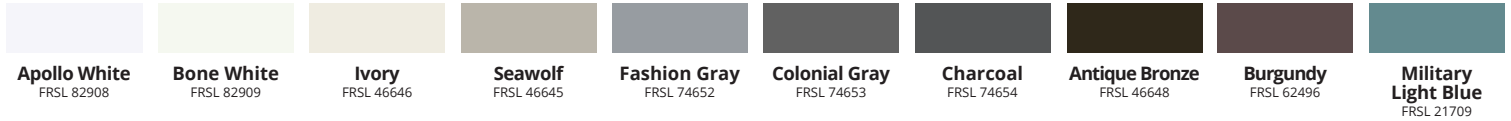

Visit <https://www.ifscoatings.com/content/assets/Uploads/brochures/IFS-Architectural-Digital-Color-Card.pdf> for additional metallic and anodic finishes.

Metal Clad STANDARD* (EXTERIOR ONLY)



Metal Clad PREMIUM*



Decoral Finishes (Powder Coat)*

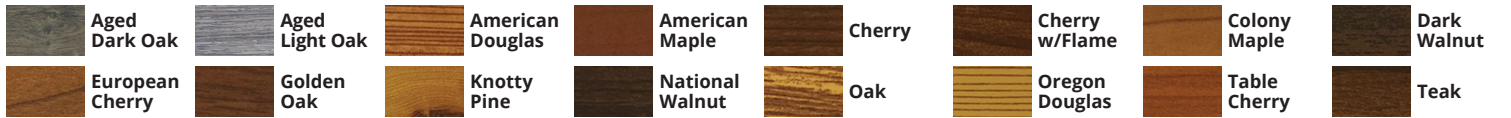

Wood Veneering (Unfinished) STANDARD*



Wood Veneering (Unfinished) PREMIUM*



Note: wood veneering is for interior applications only. Available on a limited basis due to vendor supply.

*Lead times subject to availability. ** Special order.

Note: Depending upon color selection, additional charges and increased lead times may apply. Extended warranties and service plans are available for an additional charge. Examples are shown as accurate as photography and printing processes allow. Final finish selection should be made from a physical sample; contact Solar Innovations® for samples. Product and finish options are subject to vendor availability. Solar Innovations® reserves the right to discontinue any option at any time without notice. Additional options, including custom color match, are available; contact Solar Innovations® for details.

To find out more about the features and options of our folding glass walls, visit our website at solarinnovations.com/folding-glass-walls/ or contact one of our sales designers at 800 618 0669.



GLASS SPECIFICATIONS

	Overall Unit Thickness	U-Value	R-Value	Solar Heat Gain Coefficient	Visible Light Transmission	Reflectance Out	Reflectance In	UV Transmittance
MONOLITHIC								
Clear	¼"	1.02	0.91	0.82	88%	8%	8%	62%
DOUBLE GLAZED Outside Lite/Inside Lite								
Clear/Clear	1"	0.46	2.17	0.78	82%	15%	15%	58%
180/Clear	1"	0.26	3.85	0.64	79%	15%	15%	29%
272/Clear	1"	0.25	4.00	0.41	72%	11%	12%	16%
366/Clear	1"	0.24	4.17	0.27	65%	11%	12%	5%
340/Clear	1"	0.25	4.00	0.18	39%	11%	13%	2%
180/i89	1"	0.21	4.76	0.62	77%	15%	14%	27%
272/i89	1"	0.20	5.00	0.41	70%	11%	11%	16%
366/i89	1"	0.20	5.00	0.27	63%	11%	11%	5%
340/i89	1"	0.20	5.00	0.17	38%	11%	12%	2%
Gray/Clear	1"	0.45	2.22	0.60	57%	9%	13%	32%
Gray/180	1"	0.26	3.85	0.49	53%	9%	14%	17%
Gray/272	1"	0.25	4.00	0.38	50%	8%	9%	10%
Bronze/Clear	1"	0.45	2.22	0.62	61%	10%	13%	31%
Bronze/180	1"	0.26	3.85	0.61	59%	10%	14%	17%
Bronze/272	1"	0.25	4.00	0.39	54%	8%	10%	10%
SolarBan 60/Clear	1"	0.24	-	0.39	70%	11%	12%	20%
SolarBan 70/Clear	1"	0.24	-	0.27	64%	14%	13%	6%
SolarBan 90/Clear	1"	0.24	-	0.23	51%	12%	19%	8%
TRIPLE GLAZED Outside Lite/Middle Lite/Inside Lite								
180/Clear/180	1½"	0.15	6.67	0.56	70%	20%	20%	13%
272/Clear/180	1½"	0.15	6.67	0.37	63%	15%	18%	8%
366/Clear/180	1½"	0.15	6.67	0.25	57%	14%	18%	2%
340/Clear/180	1½"	0.15	6.67	0.16	34%	13%	19%	1%

SILL COMPARISONS

Folding Glass Wall Sill Type	Application	Top Load	Bottom Load	Recessed	Surface Mount	ADA Compliant	Florida Impact Tested	Water Performance	Max. Panel Height	Max. Frame Width	Max. Header Deflection	
G2 System												
	G2 Recessed with Ramps	Interior or Exterior	Yes	Yes	Yes	No	Yes, with Sill Fill	Yes	Limited*	Varies	Varies	3/16"
	G2 Recessed Flush	Interior or Exterior	Yes	Yes	Yes	Yes	Yes, with Sill Fill	Yes	9psf	Varies	Varies	3/16"
	G2 Recessed Standard	Interior or Exterior	Yes	Yes	Yes	No	No	Yes	9psf	Varies	Varies	3/16"
	G2 Standard	Interior or Exterior	Yes	Yes	No	Yes	No	Yes	9psf	Varies	Varies	3/16"
G3 System												
	G3 Recessed with Ramps	Interior or Exterior	Yes	Yes	Yes	No	Yes, with Sill Fill	No	Limited*	Varies	Varies	3/16"
	G3 Recessed Flush	Interior or Exterior	Yes	Yes	Yes	Yes	Yes, with Sill Fill	No	Limited*	Varies	Varies	3/16"
	G3 Recessed Standard	Interior or Exterior	Yes	Yes	Yes	No	No	No	Limited*	Varies	Varies	3/16"
	G3 Standard	Interior or Exterior	Yes	Yes	No	Yes	No	No	Limited*	Varies	Varies	3/16"
	G3 Stepped with Ramps	Interior or Exterior	Yes	Yes	Yes	No	Yes	No	Limited*	Varies	Varies	3/16"
Both G2 & G3 Systems												
	Recessed Flush Hat	Interior or Exterior	Yes	No	Yes	No	Yes, with Sill Fill	No	Limited*	10' 6"	Varies	3/16"
	ADA Recessed Flush Hat	Interior or Exterior	Yes	No	Yes	No	Yes	No	Limited*	10'	Varies	3/16"
	Surface Mount	Interior or Exterior	Yes	No	No	Yes	No	No	Limited*	10' 6"	Varies	3/16"
	ADA Surface Mount	Interior or Exterior	Yes	No	No	Yes	Yes	No	Limited*	10' 6"	Varies	3/16"
	Thermal ADA	Interior or Exterior	Yes	No	No	Yes	Yes	No	Limited*	8'	16'	3/32"
	Recessed Thermal ADA	Interior or Exterior	Yes	No	Yes	No	Yes	No	Limited*	10'	Varies	1/4"

*Limited air and water performance similar to a commercial door

G2 SEGMENTED RADIUS FOLDING GLASS WALLS

G2 Thermal System

G2 Aluminum Folding Glass Wall Systems are a great way to open your environment to the outdoors. The frame uses a thermal strut system that separates the interior metal from the exterior metal. By including a thermal break, the temperature transfer between the outdoors and indoors is minimized.



The frames are available in two vertical stile widths: narrow and standard. The widths can be combined over multiple units for a unique style or kept consistent throughout. This flexibility allows multiple sightline and bottom rail configurations that can be retrofitted to match an existing opening or accommodate specific structural requirements.

G2 Non-Thermal System

G2 Non-Thermal Aluminum Folding Glass Wall Systems are ideal for mild climates and indoor uses. This system is popular for conference rooms, interior commercial entryways, and classrooms, as well as residential and commercial room dividers. Frames are available in two vertical stile widths: narrow and standard. These can be combined over multiple units for a unique style or kept consistent throughout.



Panels

- Minimum panel size: 18" wide; smaller panels may be available upon request
- Panel size up to 3' x 10'; larger panel options may be available depending on application

Glazing

- Designed to accommodate almost any monolithic, insulated, laminated, decorative, polycarbonate, or solid panel infill from $\frac{3}{16}$ " to $1\frac{1}{4}$ "

Performance

- Water performance up to 12psf, depending on sill choice and configuration
- Structurally tested up to a design pressure of 80psf
- Higher design pressure ratings available with engineering approval
- Test results available upon request

TOP & BOTTOM LOAD SILLS

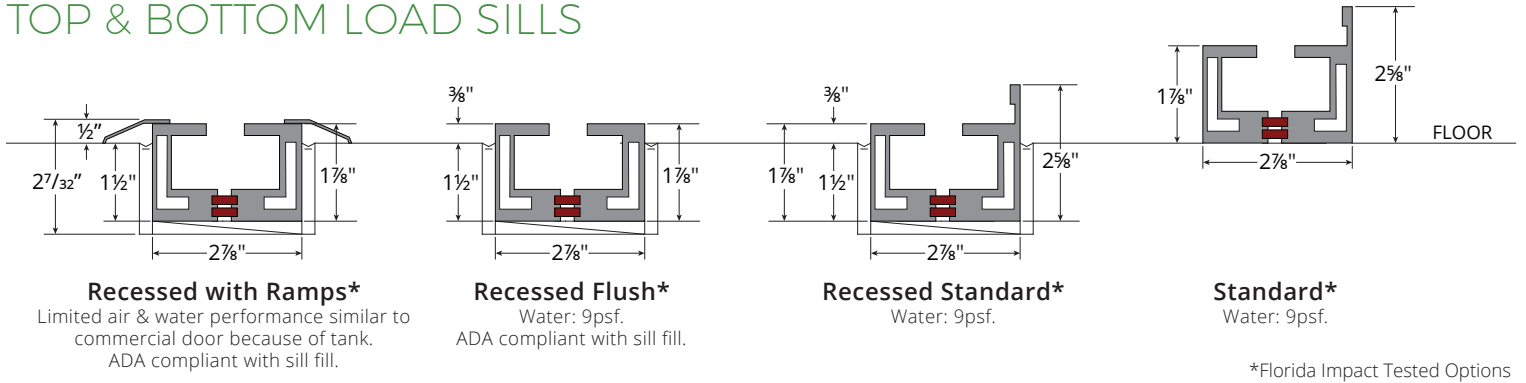

TOP LOAD ONLY SILLS

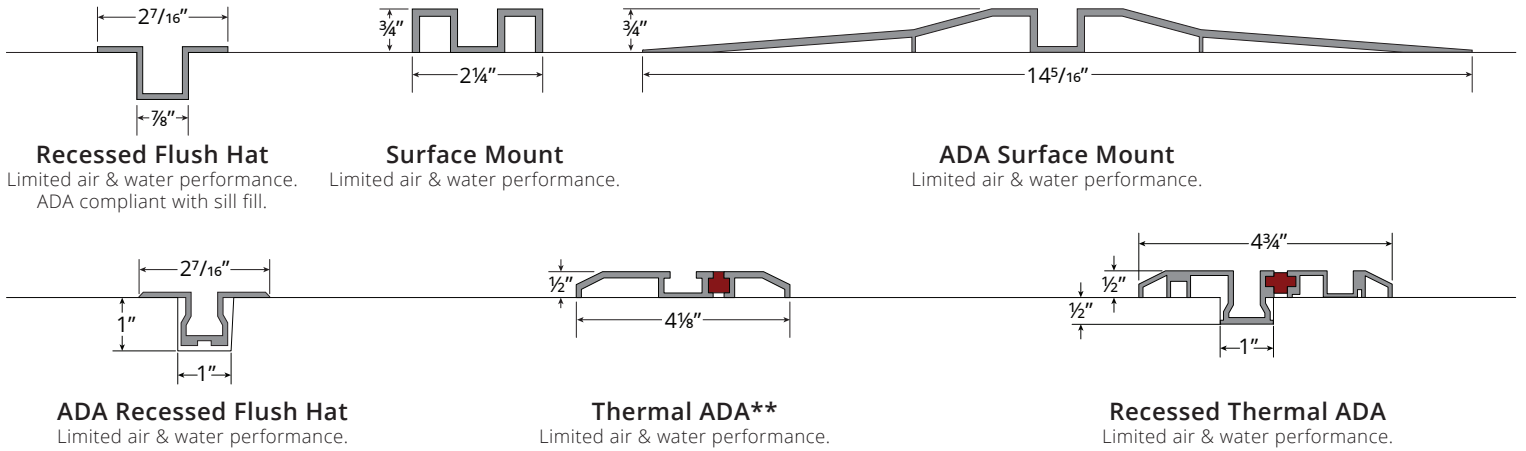

Note: Center Pivot Folding Glass Walls will get limited air and water performance.

** 8' maximum panel height, 16' maximum frame width, 3/32" maximum allowable header deflection.

VERTICAL & HORIZONTAL RAILS

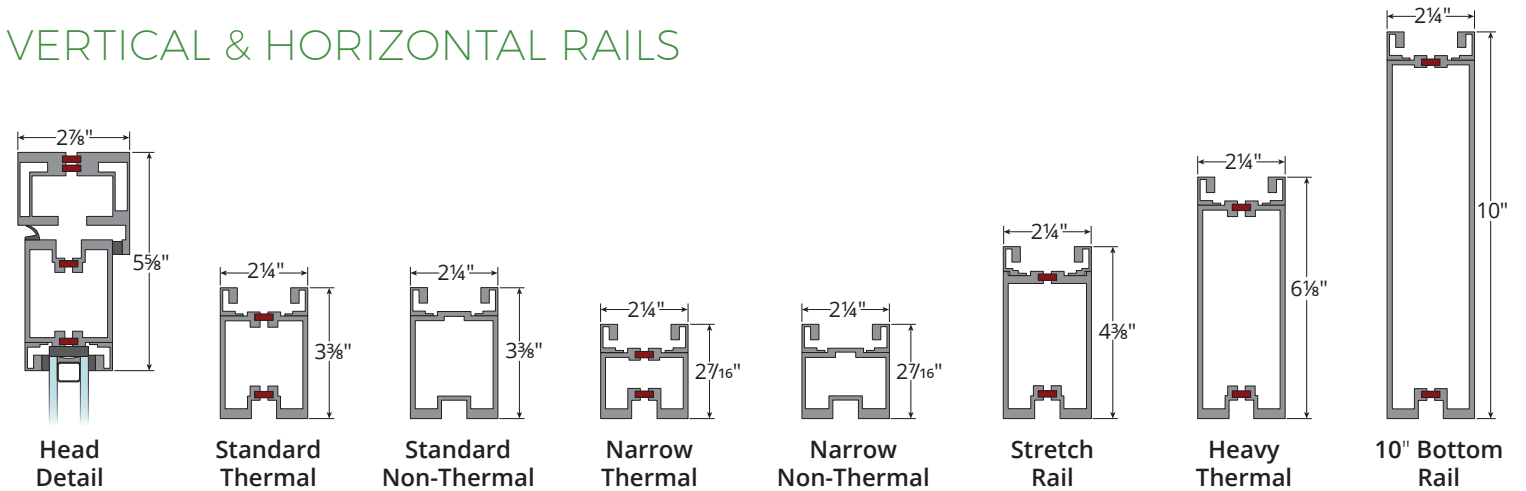

MULLIONS (True Divided Lites)

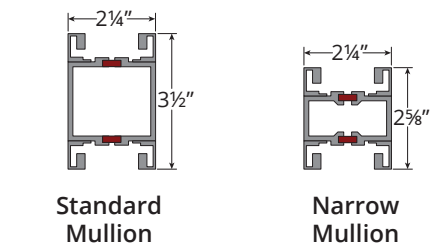

Please note: All mullions offered by Solar Innovations® include thermal break, regardless of the system.

JAMB DETAIL

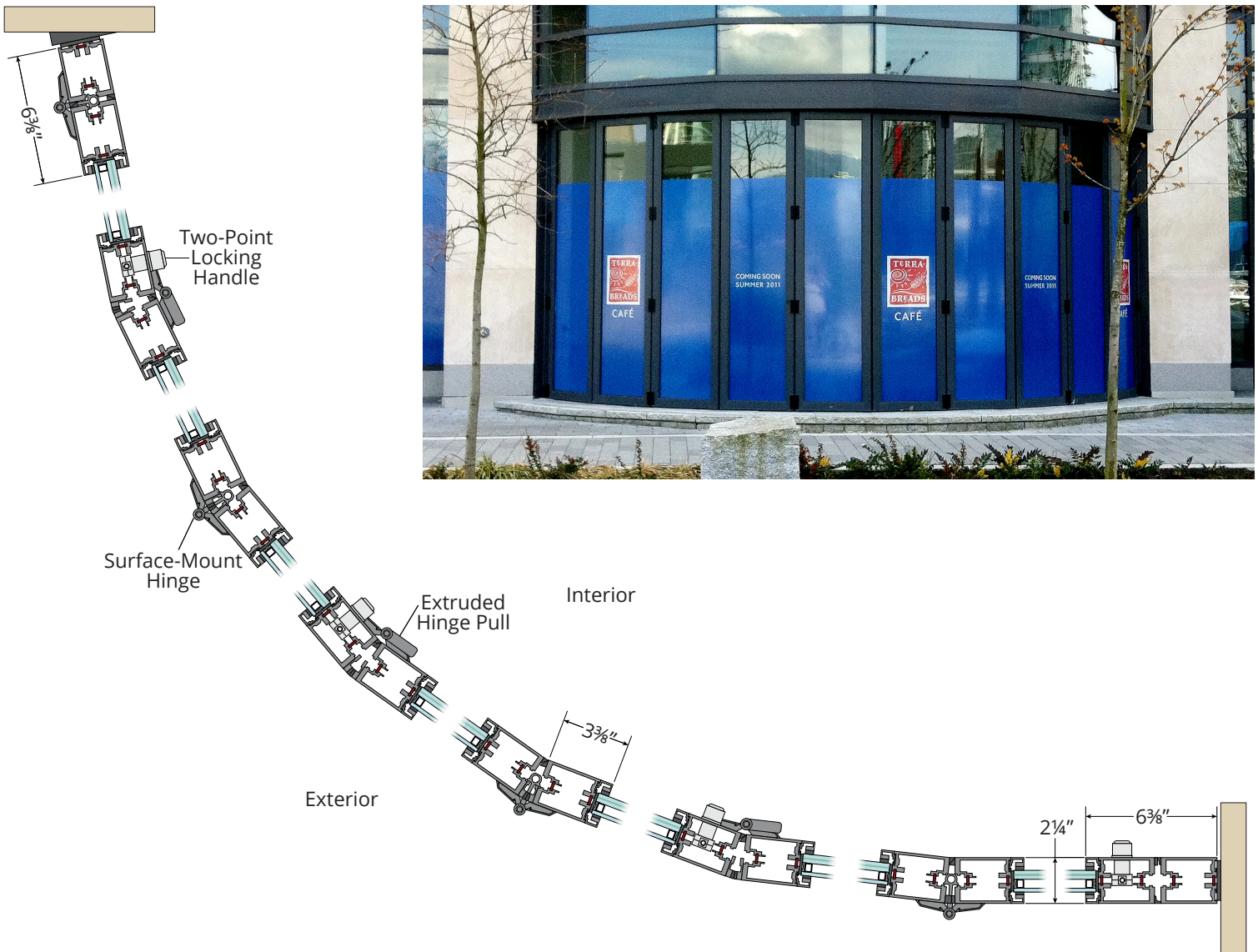

ELEVATION DETAILS

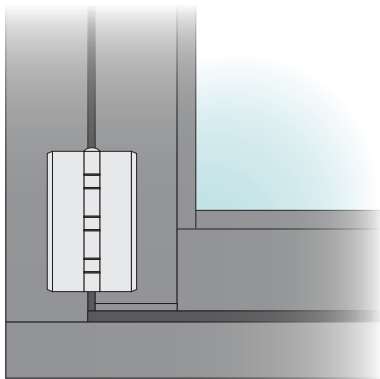

Regular G2 Jamb & Frame

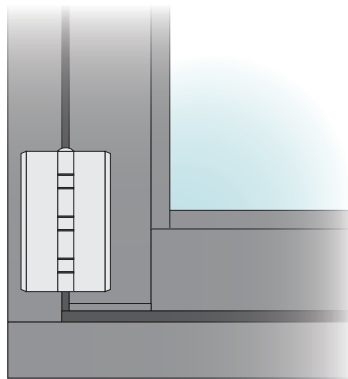

Narrow G2 Jamb & Regular G2 Frame

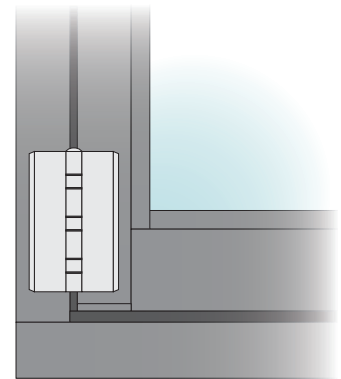

Narrow G2 Jamb & Frame

Top and bottom horizontals unable to utilize narrow framing. Options dependent upon desired size and engineering requirements.

STACKED WALL DIMENSIONS

Standard Jamb. Subtract $1\frac{5}{16}$ " for Narrow Jamb.

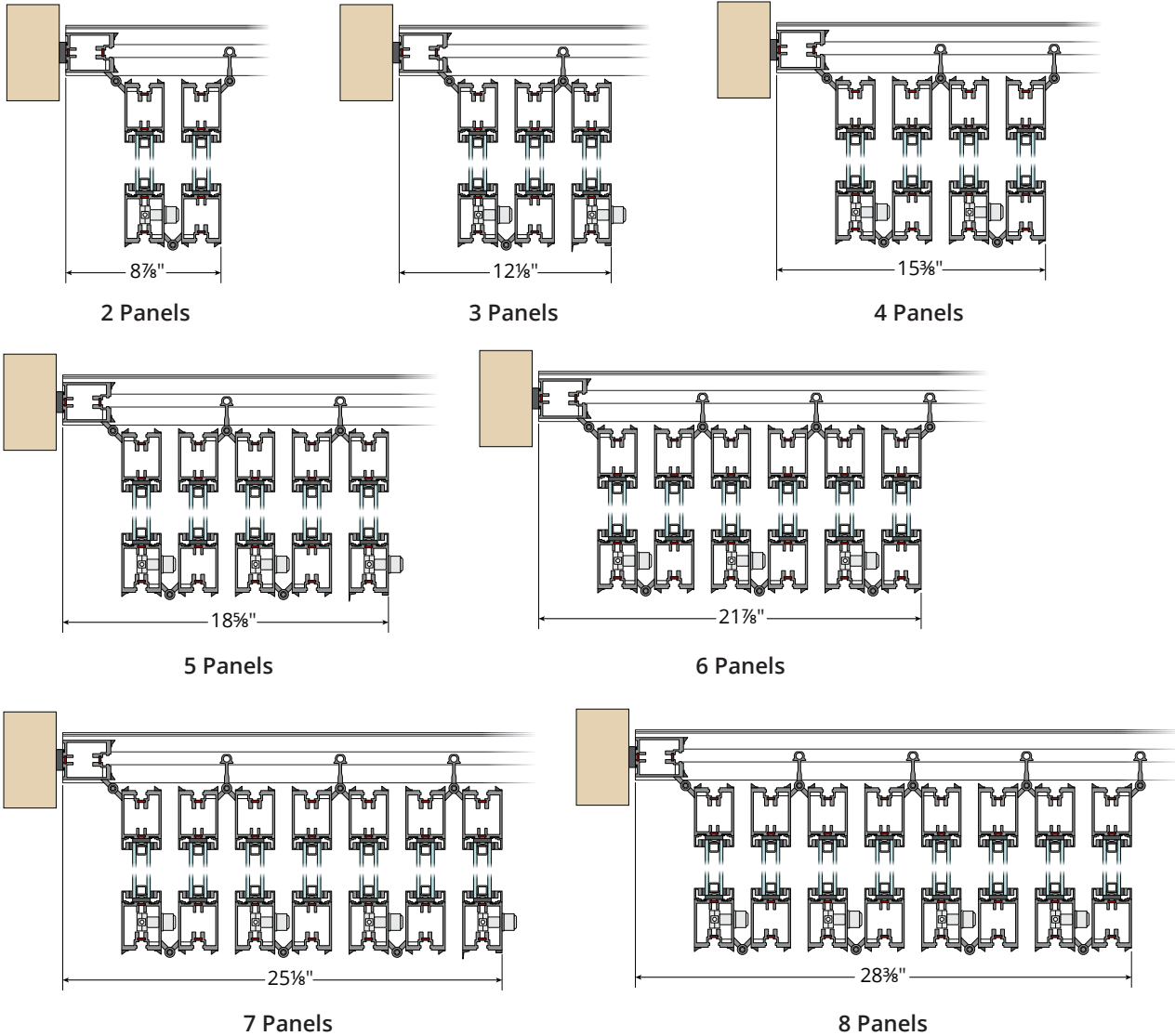

TESTING

G2 Segmented Radius Folding Glass Wall Impact Testing

Certification	Description	Panel Size	Number of Panels	Design Pressure	Water Penetration	Glass Selection	HVHZ Approved
12278.7	G2 Segmented Radius	36" x 96"	Unlimited	Max ± 70 psf	Standard Sill: 9psf Recessed Flush Sill: 9psf	1" IGU $\frac{3}{16}$ " Tempered over $\frac{7}{16}$ " Annealed Laminated (.090 SGP) Monolithic $\frac{7}{16}$ " Annealed Laminated (.090 SPG)	Yes

G2 Segmented Radius Folding Glass Wall STC & OITC Ratings

Report	Description	Sill	Glazing Thickness	Glazing Makeup	STC	OITC
F3179.01	G2 Reg Thermal	Standard	1 $\frac{1}{8}$ "	$\frac{1}{4}$ " Lami w/ .030 Acoustical Interlayer, $\frac{1}{2}$ " Air, $\frac{3}{8}$ " Lami w/ .030 Acoustical Interlayer	39	32
F3179.02	G2 Reg Thermal	Recessed Flush or Recessed Ramp	1 $\frac{1}{8}$ "	$\frac{1}{4}$ " Lami w/ .030 Acoustical Interlayer, $\frac{1}{2}$ " Air, $\frac{3}{8}$ " Lami w/ .030 Acoustical Interlayer	34	29

For more testing information visit our website at solarinnovations.com/information/testing

G3 SEGMENTED RADIUS FOLDING GLASS WALLS



G3 Thermal System

G3 Aluminum Folding Glass Wall Systems are designed for commercial and residential applications that require higher design pressures. This system has been designed to support larger glass sizes while maintaining the ease of operation as our G2 System. The G3 System offers exceptional air, water, structural, acoustical, and thermal performance using a thermal strut system that separates the interior metal from the exterior metal. By including this thermal break, the temperature transfer between the outdoors and indoors is minimized.

Frames are available in three vertical stile widths: standard, narrow, and xtra narrow. You can select a consistent vertical width or mix and match the three stile widths to create a truly unique design. This system was created with similar sightlines to the G2 Systems so that the two could be used together, if desired. The flexibility of both systems allows multiple sightline and bottom rail configurations that can be retrofitted to match an existing opening or accommodate specific structural requirements.

Panels

- Minimum panel width: 24"; smaller panels may be available based upon request
- Panel size up to 3' x 15'; larger panel options may be available depending on application

G3 Non-Thermal System

The G3 Non-Thermal System is ideal for applications that do not require thermal performance, including mild climates and indoor uses — this system is popular for interior entryways and room dividers.

G3 Marine Glazed System

Our G3 Extra Narrow Marine Glazed Folding Glass Wall System optimizes the view of the outdoors by minimizing the vertical stiles. It uses a patented design to combine vertical marine glazing with horizontal stop glazing in order to create a much narrower vertical frame than conventional stop glazed doors. The G3 Extra Narrow Marine Glazed System is the narrowest four-sided thermally broken glazed bi-fold door in the market.



Glazing

- Designed to accommodate almost any monolithic, insulated, laminated, decorative, polycarbonate, or solid panel infill from ¼" to 1¾"

TOP & BOTTOM LOAD SILLS

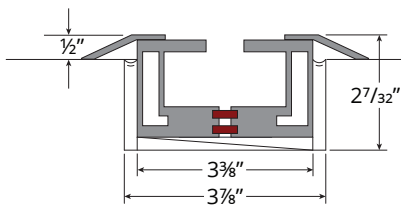

Recessed with Ramps

Limited air & water performance similar to commercial door because of tank.
ADA compliant with sill fill.

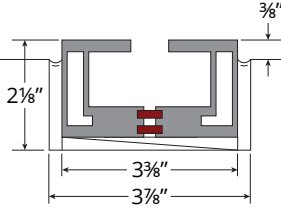

Recessed Flush

Limited air & water performance similar to commercial door because of tank.
ADA compliant with sill fill.

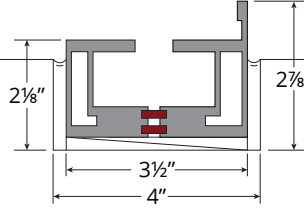

Recessed Standard

Limited air & water performance similar to commercial door because of tank.
ADA compliant with sill fill.

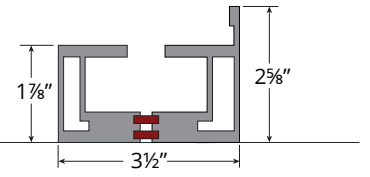

Standard

Limited air & water performance similar to commercial door because of tank.
ADA compliant with sill fill.

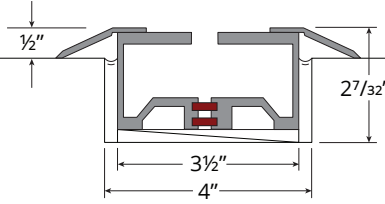

G3 Stepped

Limited air & water performance similar to commercial door because of tank.
ADA compliant.

TOP LOAD ONLY SILLS

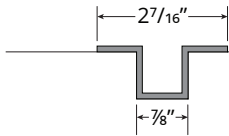

Recessed Flush Hat

Limited air & water performance.
ADA compliant with sill fill.

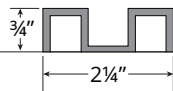

Surface Mount

Limited air & water performance.

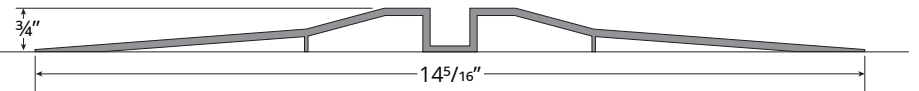

ADA Surface Mount

Limited air & water performance.

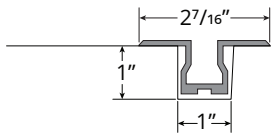

ADA Recessed Flush Hat

Limited air & water performance.

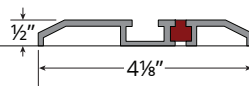

Thermal ADA**

Limited air & water performance.

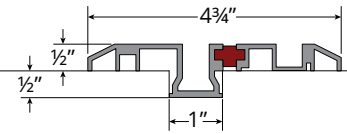

Recessed Thermal ADA

Limited air & water performance.

Note: Center Pivot Folding Glass Walls will get limited air and water performance.

** 8' maximum panel height, 16' maximum frame width, 3/32" maximum allowable header deflection.

VERTICAL & HORIZONTAL RAILS

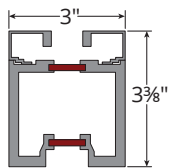

Standard Thermal

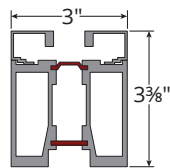

LT Thermal

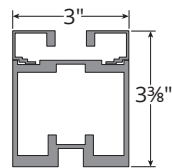

LT Non-Thermal

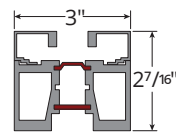

LT Narrow Thermal

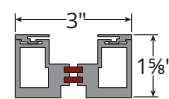

Extra Narrow Thermal (Vertical)

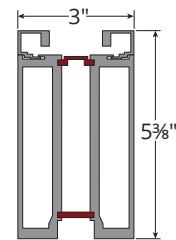

Stretch Rail

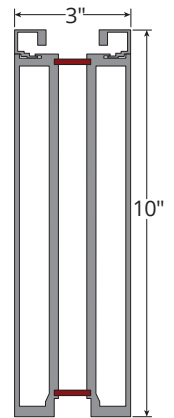

10" Bottom Rail

HEADS

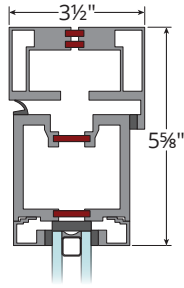

Standard Head & Frame Detail

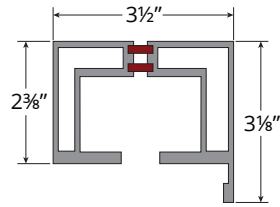

1 1/2" Dual Wheel Head

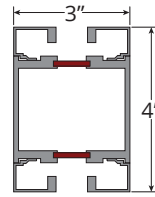

Standard Mullion

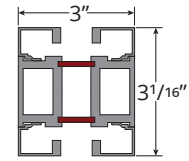

Narrow Mullion

MULLIONS

(True Divided Lites)

Please note: All mullions offered by Solar Innovations® include thermal break, regardless of the system.

JAMB DETAIL

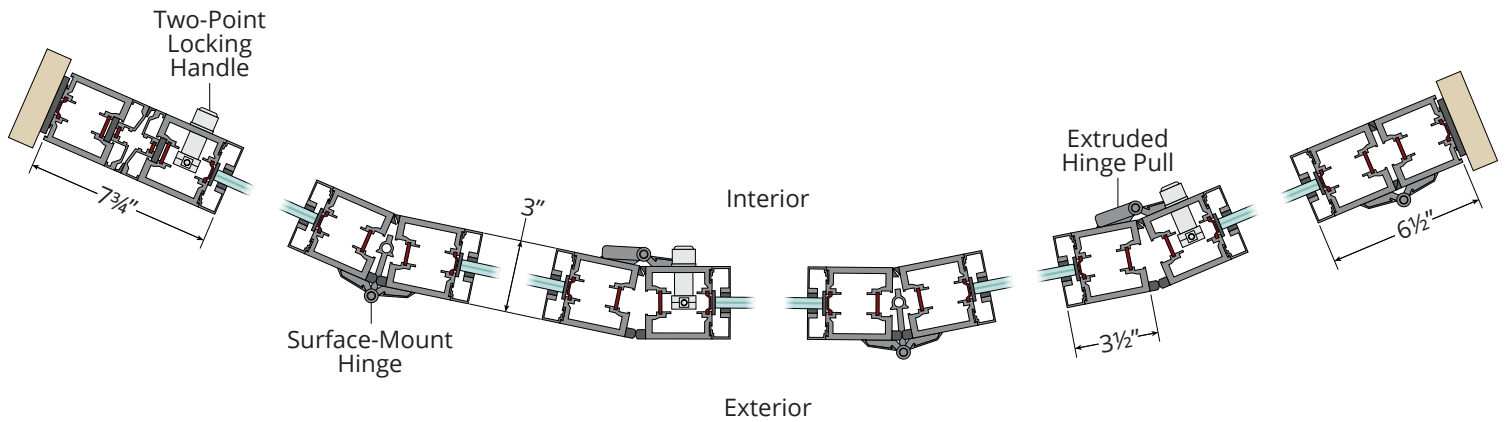

ELEVATION DETAILS

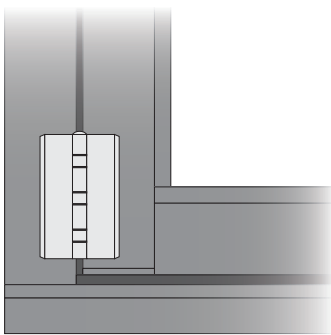

Standard G3 Jamb & Frame

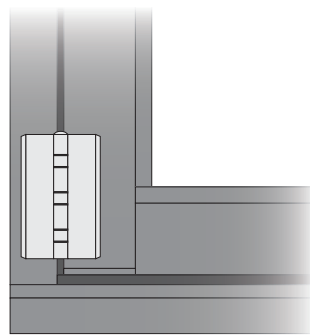

Narrow G3 Jamb & Standard G3 Frame

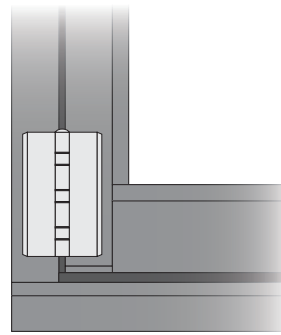

Narrow G3 Jamb & Frame

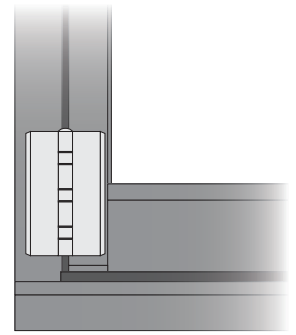

Extra Narrow G3 Panel Vertical and G3LT Narrow Jamb Frame

Top and bottom horizontals unable to utilize narrow or extra narrow framing. Options dependent upon desired size and engineering requirements.

STACKED WALL DIMENSIONS

Standard Jamb. Subtract $\frac{15}{16}$ " for Narrow Jamb.

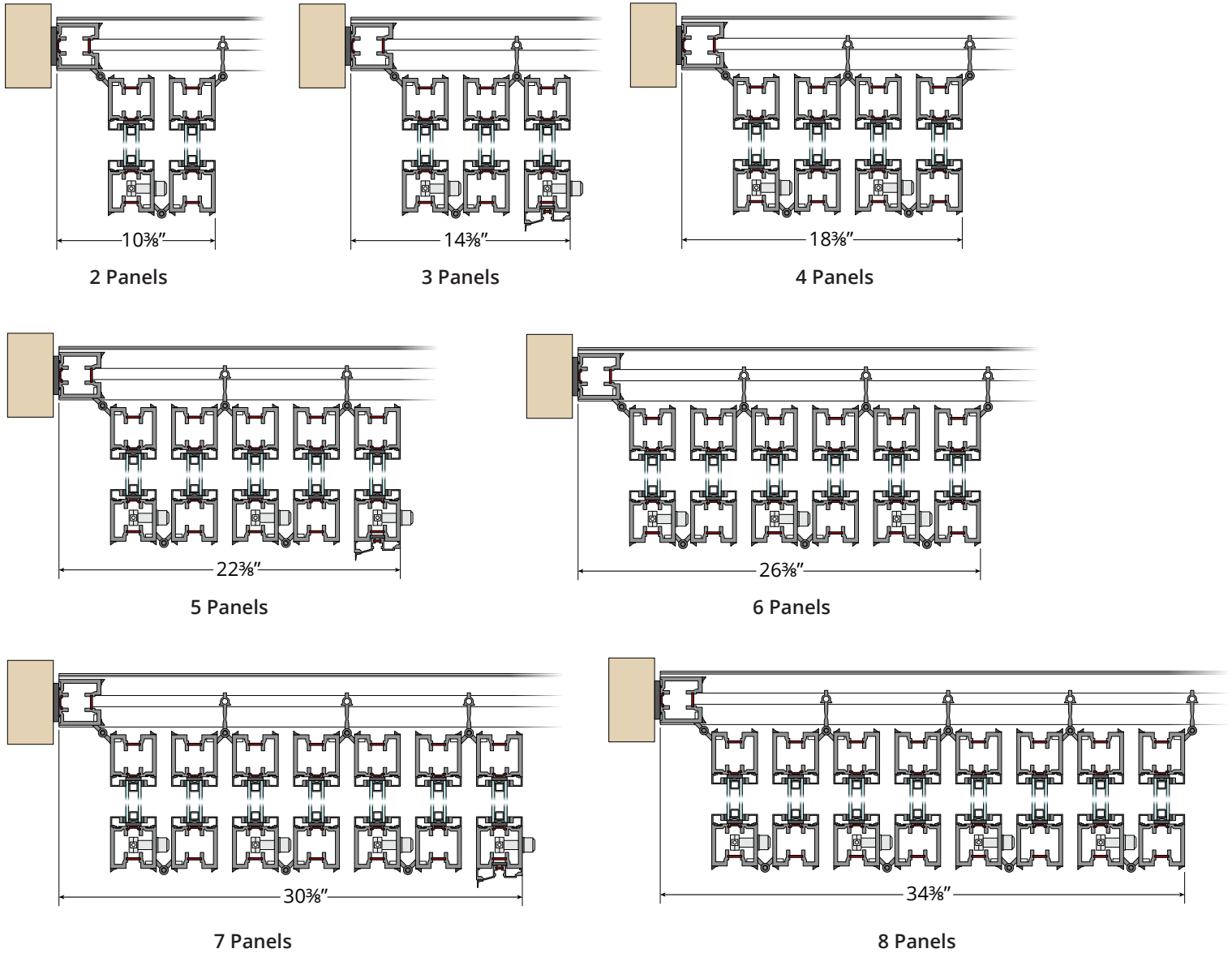

TESTING

G3 Segmented Radius Folding Glass Wall STC & OITC Ratings

Report	Description	Sill	Glazing Thickness	Glazing Makeup	STC	OITC
F3184.01	G3 LT Thermal	Standard	1 $\frac{1}{8}$ "	$\frac{1}{4}$ " Lami w/ .030 Acoustical Interlayer, $\frac{1}{2}$ " Air, $\frac{3}{8}$ " Lami w/ .030 Acoustical Interlayer	39	32
F3184.02	G3 LT Thermal	Recessed Flush or Recessed Ramp	1 $\frac{1}{8}$ "	$\frac{1}{4}$ " Lami w/ .030 Acoustical Interlayer, $\frac{1}{2}$ " Air, $\frac{3}{8}$ " Lami w/ .030 Acoustical Interlayer	38	31
I0249.02	G3 LT Narrow Thermal	Standard	1 $\frac{9}{16}$ "	$\frac{3}{8}$ " Lami w/ .030 PVB Interlayer, $\frac{3}{4}$ " Air, $\frac{3}{8}$ " Lami w/ .030 PVB Interlayer	45	35
I0249.04	G3 LT Narrow Thermal	Recessed Flush	1 $\frac{9}{16}$ "	$\frac{3}{8}$ " Lami w/ .030 PVB Interlayer, $\frac{3}{4}$ " Air, $\frac{3}{8}$ " Lami w/ .030 PVB Interlayer	44	35

For more testing information visit our website at solarinnovations.com/information/testing